

# Safety Instructions



Before use, read the instructions carefully and familiarise yourself with the machine.

## SAFETY PRECAUTIONS

When using electrical tools, basic safety precautions should always be used including the following:

- Read and save all instructions.
- Connect through an RCD adaptor.
- Unplug from outlet when not in use, before putting on or taking off any parts and before cleaning.
- To protect against electrical shock, do not immerse cord, plug or appliance in water or any other liquid.
- Do not operate any product with a damaged cord or plug, if the product malfunctions or it is dropped or damaged in any way.
- The use of attachments not recommended or sold by Plasplugs may cause fire, electrical shock or injury.
- Keep your work area clean – Cluttered benches invite accidents.
- Do not use in dangerous environments. Do not use in damp or wet conditions or expose machine in rain. Keep your working area well lit.
- Do not let the cord hang over the edge of table or counter, or touch hot surfaces.
- Do not use product or attachments for other than intended purpose.
- Do not leave product unattended whilst it is operating.
- Do not overreach – keep proper footing and balance at all times.
- Keep all non-users a safe distance from the work area, especially children.
- Never touch the moving cutting wheel.
- Grinding generates sparks – keep away all flammable substances and materials.
- Maintain all tools with care. Keep tools sharp and clean for best and safest performance.
- Never stand on tools.
- Always check for damaged parts before operation. Damaged parts should be properly repaired and replaced.
- Thermal cut out switch will prevent the motor from overheating.

## USER PRECAUTIONS

- Wear proper apparel – remove all loose clothing, neckties, rings, bracelets and other jewellery that may get caught in moving parts.
- Non-slip footwear is recommended.
- Wear protective hair covering to contain long hair.
- Ear protection and gloves are recommended.
- Always use safety glasses. NB. Everyday eye-glasses do not contain impact resistant lenses – they are NOT safety glasses.
- Always use face or dust masks if cutting operation is dusty.
- Always connect to an electrical power point using an approved RCD circuit breaker. This is an essential safety precaution.
- For safety and to prolong the motor life, only switch the Tile Cutter on before cutting a tile. Switch off immediately after use.

## ELECTRICAL SAFETY

Operate this machine only on a supply equipped with a 30mA earthed current-limiting circuit breaker. The RCD must be used correctly, including testing it regularly. If the cable or plug has been damaged, repairs must be carried out by the manufacturer.

Check the mains voltage is identical to that shown on the rating plate on the machine.

Use extension cords fully extended, intended for outdoor use. Ensure that the electrical rating and cord length is correct for the tool. Do not use damaged extension cords.

## INTRODUCING YOUR PRO-TILER PLUS TILE CUTTER

1. Motor Base Unit & Water Reservoir
2. Power Switch
3. Cutter Guide
4. Water Reservoir Cover/Mitre Guide
5. Splash Guard/Riving Blade Assembly
6. Spanner
7. Drain Plug
8. Bench Stops

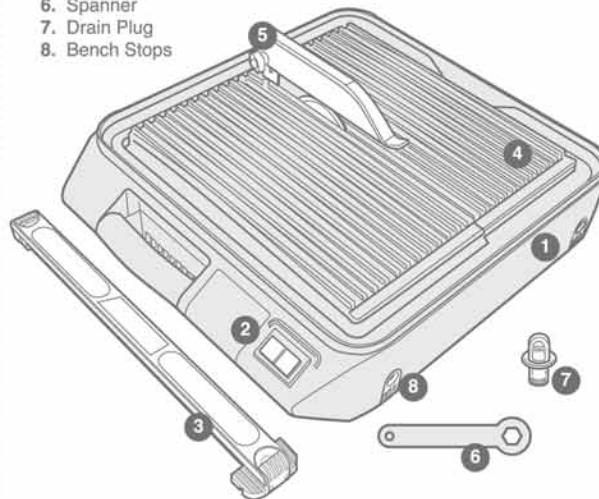

### PREPARING FOR USE

- Check that the drain plug is secure (diag 1).
- Ensure the cutter is secure on a flat surface. Use the bench stops to prevent the machine from sliding forwards on a smooth work surface (diag 2).
- It is vitally important to have the riving blade (guard support) accurately aligned with the cutting wheel. It is more convenient to do this with the guard removed as illustration (diag 3) shows. Use a steel rule touching the blade edges and move the riving blade to align with the wheel.
- Ensure cutter is on a flat surface.
- Always ensure that the guards are in place and in working order.
- Connect to electrical power point using an approved RCD circuit breaker. This is an essential safety precaution.
- For safety and motor life only switch the Tile Cutter on just before cutting a tile.
- Switch off immediately after use.
- Use adequate eye and hand protection as specified.

### USING THE PRO-TILER PLUS TILE CUTTER

- Remove the water reservoir cover/mitre guide. Fill with water to a depth of approx 20mm (7/8") or to the water level engraved on body. Replace the cover.
- Adjust splash guard up or down so that it is just above the tile surface (diag 4).

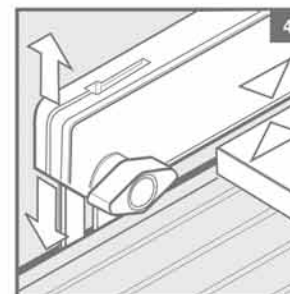
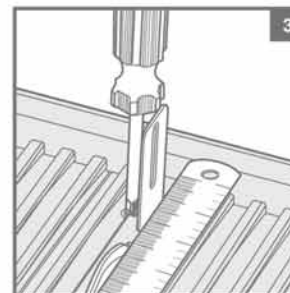
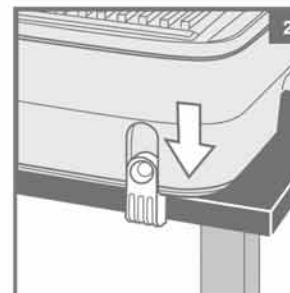
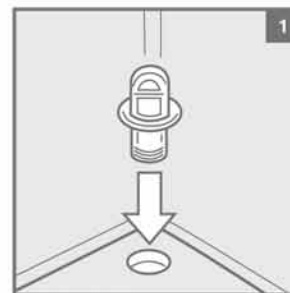

- Fit the cutter guide to the top on either side with the lever up. Adjust the position and clamp to lock - Do not use undue force and ensure the lock is correctly located (diag 5).
- To adjust/move cutter guide, push levers into downwards position and move as desired. To relock, push levers upwards (diag 6). - Do not use undue force and ensure the lock is secured.

### HELPFUL HINTS

- Intermittent use of the cutting wheel will prolong its life.
- Always stop regularly and clean down with a damp cloth or brush for effective results.
- Cutting widths can be set accurately by reading off the scale on the edge of the machine.
- Switch off immediately after use.
- If you experience excessive chipping with certain tiles (especially high glaze), it may be beneficial to cut the tile face down.
- Ensure work surface is kept clean & clear of debris at all times to prevent scratching.

### CUTTING STRAIGHT EDGES

- Line up the tile where the cut is required, with the diamond cutting wheel. Use the cutter guide alongside the tile edge for support. Push the tile towards the wheel (diag 7), using steady and even pressure. **Do not use excess pressure** – if this is needed, check for alignment of the Riving Blade, Cutting Guide or check if the diamond wheel is worn.

### CUTTING 22.5° & 45° MITRES

- Lift up the mitre guide and locate stand lug slots on the inner edge of tile cutter (diag 8). The mitre guide should then be locked in its position at 22.5° or 45°. Place the tile face down on the guide and push towards the cutting wheel.

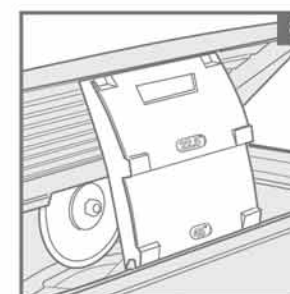
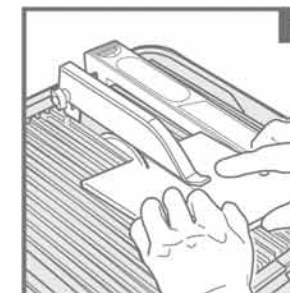
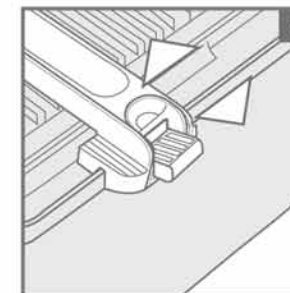
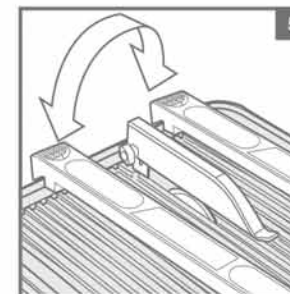

### CUTTING CURVES, SQUARES AND CIRCLES

- Gloves are recommended for this application. Draw the shape required onto the tile.  
A chinagraph pencil is recommended for marking the tile. Product code reference **TMS854**.  
Lift up the splash guard and use the top of the wheel to cut your shape (diag 9). Recommended for advanced users only.

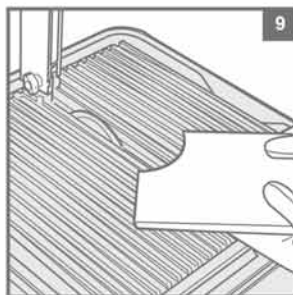

### REPLACEMENT 110MM CUTTING WHEEL

- Always use Plasplugs genuine replacement wheels. Product code reference **RDW110** or **HGDW110**.

Remove the water reservoir cover. Remove nut and large washer from shaft, using spanner provided, then pull off used wheel. Fit new wheel on to shaft ensuring that the label/rotation arrow faces outwards (diag 10). Refit washer and nut and tighten with spanner.

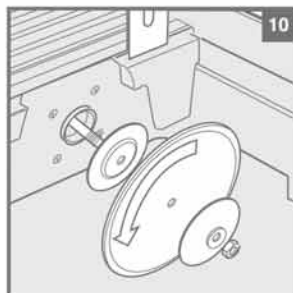

### CARE & CLEANING

- Before cleaning, disconnect from the mains.
- Always clean sludge thoroughly from tray after use.
- Wash with a clean damp cloth. Do not use a water jet or hose.
- Keep the tile cutter free from oil and grease and store in dry conditions.
- No regular servicing is required. In the unlikely event of operating difficulty, please contact Plasplugs direct.

### ONE YEAR GUARANTEE

Your Plasplugs product is guaranteed for one year from date of purchase, against electrical and mechanical defects in material and workmanship. Repairs or part replacement required as a result of such defects will be made free of charge during this period. Proof of purchase must be provided.

This guarantee does not cover damage caused by misuse, negligence or use on current or voltage other than that stamped on the product. The guarantee is invalid if the machine has been dismantled or interfered with in any way and persons other than Plasplugs' consumer care department have attempted repairs.

This guarantee is in lieu of any other warranty expressed or implied. This warranty does not affect your statutory rights.

For after sales care or any other additional questions you may have regarding Plasplugs tiling tool product range, please contact our free-phone number on 0800 243159.

### TECHNICAL SPECIFICATION

Power Supply: ~230V 50hz  
Power: 375W  
Geared Output: 4600min-1 (no load)  
Max. Sound Power Level: 90dB(A)  
To cut: Ceramic, Quarry, Terracotta, Slate, Marble & Frost Proof Tiles  
Max. Cutting Depth: 20mm  
Max. Wheel Diameter: 110mm

### MAIN MATERIALS:

Motor: Aluminium (AL) - Steel (AC) - Copper (CU)  
Machine: HIPS (AC) inbox



**PLASPLUGS®**

## A range of complementary Tile Care & Maintenance products



### Installing New Tiles

- Tile Sealer TLIMP110
- Wax & Polish Remover WPR100
- Terracotta Shine Seal TCSS112
- Floor Tile Polish FTP105



### Renovation

- Heavy Duty Tile Cleaner HDTCL111
- Grout Cleaner GCL107
- Mould Remover MSPR109



### Maintenance

- Tile Clean & Shine SFL101
- Marble Clean & Shine MCS104
- Bathroom & Wall Tile Cleaner BWTCL108
- Laminate Clean & Shine LCS103

### CERTIFICATE OF CONFORMITY DWW110 PRO-TILER PLUS TILE CUTTER

I, the undersigned N.A. Turner of Plasplugs Limited, Wetmore Road, Burton-on-Trent, Staffordshire, DE14 1SD, certify that the above product has been tested and found to comply with:  
89/392/EEC machine safety directive  
72/23 EEC low voltage directive  
89/336/EEC EMC directive  
VDE 0741:1963-08; VDE 0740-502:1992-12 (in reference)  
EN 50144-2-5: 1997-03 (sec. 7.1 & 18.101)

This product is protected under the laws of Intellectual Rights, we will take legal action against any infringement.

Signed

N.A. Turner, Director  
June 2005



Waste electrical products should not be disposed of with household waste. Please recycle where facilities exist. Check with your local authority or retailer for recycling advice.

**PLASPLUGS®**

Plasplugs Ltd  
Wetmore Road Burton on Trent Staffordshire DE14 1SD UK  
Tel: +44(0) 1283 530303 Fax: +44(0) 1283 531246  
www.plasplugs.com

© 2005 Plasplugs Ltd

Due to minor changes in design or otherwise, the product you buy may differ slightly from the one shown in this manual. Approved by EEC Standards.

Part No: 062506311

**PLASPLUGS®**

# Pro-Tiler Plus

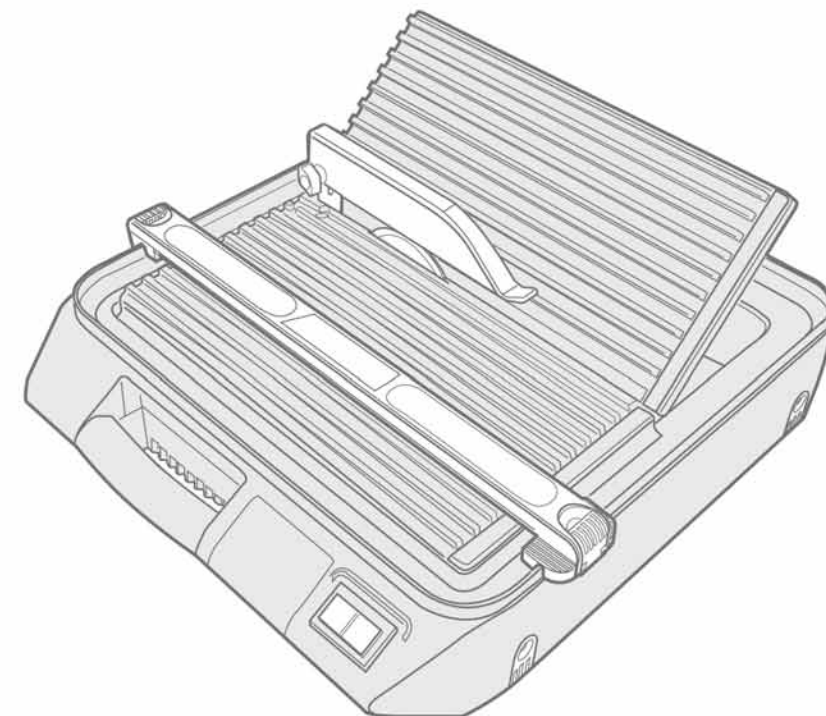

**MODEL NO: DWW110**

**FOR YOUR SAFETY. PLEASE READ BEFORE USE.**